

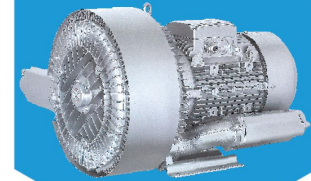

High pressure vortex air pump
Industrial dust collector
Y series motor

HIGH PRESSURE
VORTEX AIR PUMP



INDUSTRIAL
DUST COLLECTOR



VORTEX
BLOWER



VERATTI ELECTRICAL CO., LTD.



LEADER OF VORTEX BLOWER / VORTEX AIR PUMP

Company Introduction

Taizhou VERATTI Electrical Co., Ltd. is a modern and comprehensive enterprise that integrates design, research, development, manufacture, sales into one. We are specialized in designing, manufacturing and selling vortex air pump, ring blower, high pressure fan, gas ring vacuum pump, motor series etc.

Our Manufacture Base is located in Wenling, Taizhou city with charming scenery and convenient transport facilities.

Ningbo-Taizhou-Wenzhou Expressway and high speed rail way cross Taizhou Wenling city. It is only 5km away from Luqiao Airport and Wenling Railway Station. Ningbo and Shanghai port are within very short distance away.

VERATTI persists in high-tech innovation. We keeps surpassing ourselves. At the same time of pursuing high quality, it continuously perfects its service system. We always abides by core concept of "equality, mutual benefits, fine credit and sincerity". We look forward to promoting the more excellent products to global markets.

To create a world-class quality

VERATTI ELECTRICAL

GB-250



GB series vortex air pump performance curve
(for reference only, do not take it for testing standard)

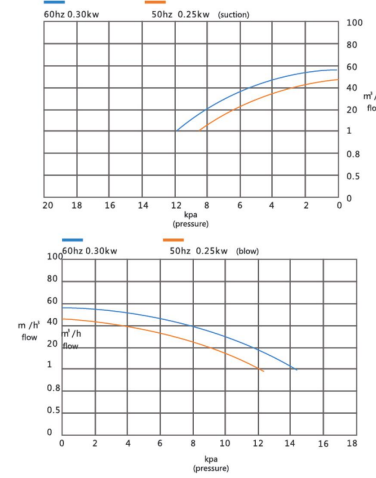

GB-370



GB series vortex air pump performance curve
(for reference only, do not take it for testing standard)

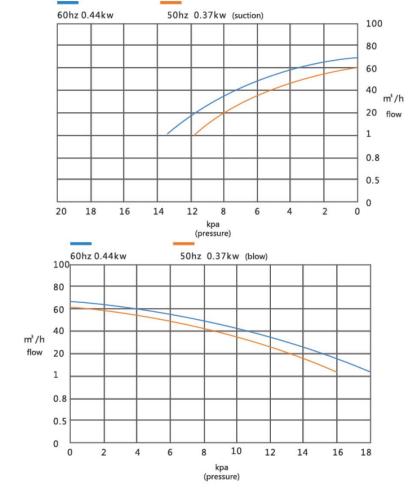

Type	Voltage V	Current A	Frequency Hz	Max Pressure KPa	Max flow m ³ /h	Max Vacuum KPa	Power kw	Rotational Speed r/min	Noise dB(A)	N.W. kg	G.W. kg	Packing Size (cm)
GB-250	220	2.5(3.0)	50(60)	12(14)	48(57)	8.5(10)	0.25(0.30)	2800(3400)	<56	10.6	11.2	31×28×28
GB-250S	△220 Y380	1.24(1.68) 0.72(0.97)	50(60)	12(14)	48(57)	8.5(10)	0.25(0.30)	2800(3400)	<56	10	10.5	31×28×28
GB-370	220	3.5(4.2)	50(60)	16(19)	60(70)	11(13)	0.37(0.44)	2800(3400)	<56	11	11.7	31×28×28
GB-370S	△220 Y380	1.55(2.11) 1.05(1.16)	50(60)	16(19)	60(70)	11(13)	0.37(0.44)	2800(3400)	<56	10.6	11.2	31×28×28

GB-550



GB series vortex air pump performance curve
(for reference only, do not take it for testing standard)

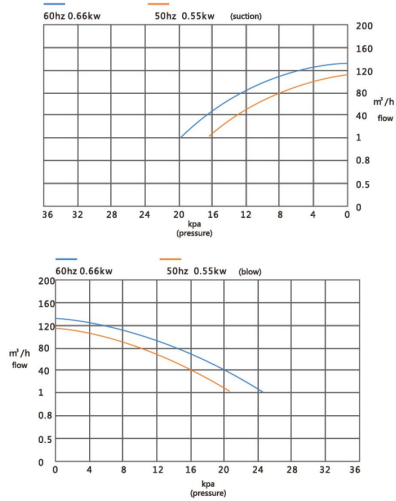

GB-750



GB series vortex air pump performance curve
(for reference only, do not take it for testing standard)

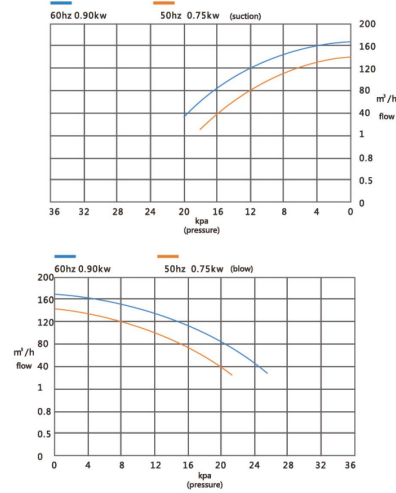

GB-1100



GB series vortex air pump performance curve
(for reference only, do not take it for testing standard)

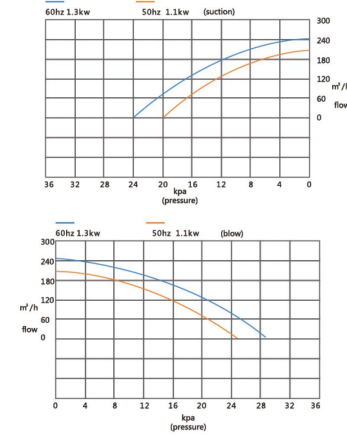

GB-1500



GB series vortex air pump performance curve
(for reference only, do not take it for testing standard)

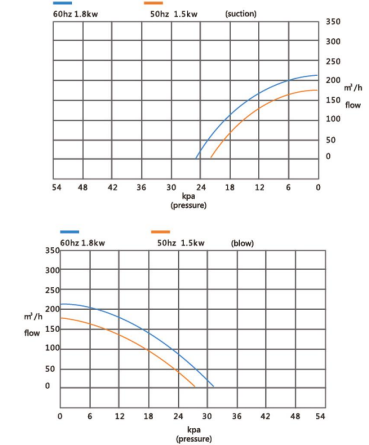

Type	Voltage V	Current A	Frequency Hz	Max Pressure KPa	Max flow m ³ /h	Max Vacuum KPa	Power kw	Rotational Speed r/min	Noise dB(A)	N.W. kg	G.W. kg	Packing Size (cm)
GB-550	220	4.8(5.76)	50(60)	20(24)	110(132)	16(19)	0.55(0.66)	2800(3400)	<60	12.6	14.1	32×31×30
GB-550S	Δ 220 Y380	2.51(3.01) 1.45(1.74)	50(60)	20(24)	110(132)	16(19)	0.55(0.66)	2800(3400)	<60	12	13.5	32×31×30
GB-750	220	6.3(7.56)	50(60)	22(25)	145(170)	18(20)	0.75(0.90)	2800(3400)	<60	16.5	18.0	35×32×33
GB-750S	Δ 220 Y380	3.31(4.10) 1.81(2.37)	50(60)	22(25)	145(170)	18(20)	0.75(0.90)	2800(3400)	<60	16.0	17.5	35×32×33

Type	Voltage V	Current A	Frequency Hz	Max Pressure KPa	Max flow m ³ /h	Max Vacuum KPa	Power kw	Rotational Speed r/min	Noise dB(A)	N.W. kg	G.W. kg	Packing Size (cm)
GB-1100	220	8.7(10.44)	50(60)	25(30)	210(245)	20(24)	1.1(1.3)	2800(3400)	<60	23	24.7	37×37×38
GB-1100S	Δ 220 Y380	4.36(5.88) 2.52(3.42)	50(60)	25(30)	210(245)	20(24)	1.1(1.3)	2800(3400)	<60	21.5	22.9	37×37×38
GB-1500	220	11.8(14.16)	50(60)	26(31)	220(255)	21(25)	1.5(1.8)	2800(3400)	<60	23.4	28	37×37×38
GB-1500S	Δ 220 Y380	5.96(8.20) 3.44(4.74)	50(60)	26(31)	220(255)	21(25)	1.5(1.8)	2800(3400)	<60	22.5	26	37×37×38

GB-2200



GB series vortex air pump performance curve (for reference only, do not take it for testing standard)

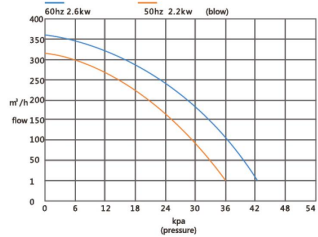
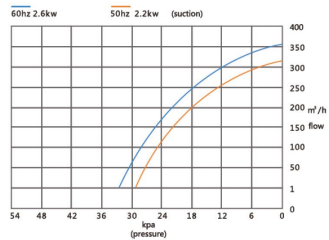

GB-3000



GB series vortex air pump performance curve (for reference only, do not take it for testing standard)

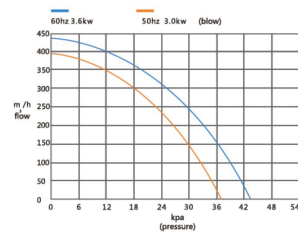
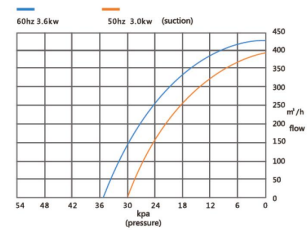

GB-4000



GB series vortex air pump performance curve (for reference only, do not take it for testing standard)

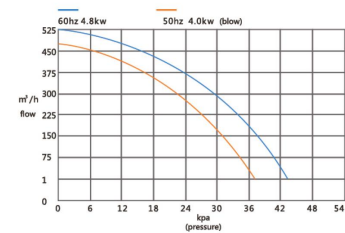
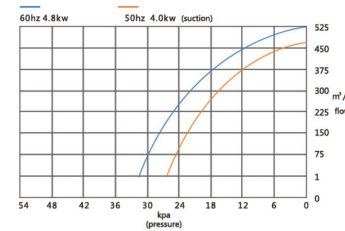

GB-5500



GB series vortex air pump performance curve (for reference only, do not take it for testing standard)

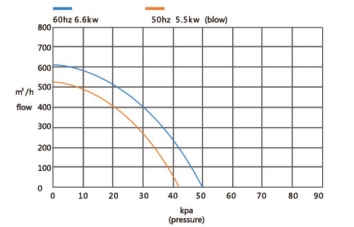
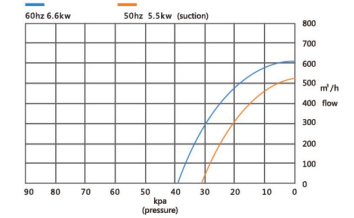

Type	Voltage V	Current A	Frequency Hz	Max Pressure KPa	Max flow m ³ /h	Max Vacuum KPa	Power kw	Rotational Speed r/min	Noise dB(A)	N.W. kg	G.W. kg	Packing Size (cm)
GB-2200S	Δ 220 Y 380	8.52(10.22) 4.92(5.91)	50(60)	36(43)	325(365)	28(33)	2.2(2.6)	2800(3400)	<70	29	31.5	42×42×42
GB-3000S	Δ 220 Y 380	11.07(13.29) 6.39(7.67)	50(60)	37(44)	390(430)	30(35)	3.0(3.6)	2800(3400)	<70	38	43.5	43×44×44

Type	Voltage V	Current A	Frequency Hz	Max Pressure KPa	Max flow m ³ /h	Max Vacuum KPa	Power kw	Rotational Speed r/min	Noise dB(A)	N.W. kg	G.W. kg	Packing Size (cm)
GB-4000S	Δ 220 Y 380	14.15(16.97) 8.17(9.8)	50(60)	38(45)	475(525)	28(33)	4.0(4.8)	2800(3400)	<70	47	54	46×46×50
GB-5500S	Δ 220 Y 380	19.23(23.21) 11.1(13.4)	50(60)	42(50)	530(616)	34(38)	5.5(6.6)	2800(3400)	<70	62	71	48×50×52

GB-7500



GB series vortex air pump performance curve
(for reference only, do not take it for testing standard)

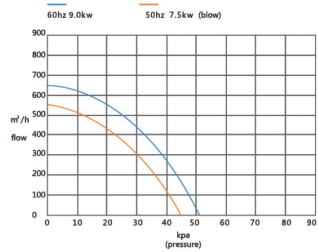
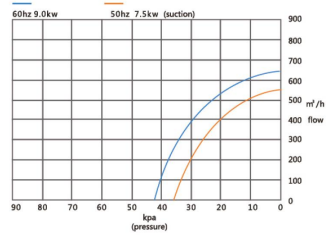

GB-11000



GB series vortex air pump performance curve
(for reference only, do not take it for testing standard)

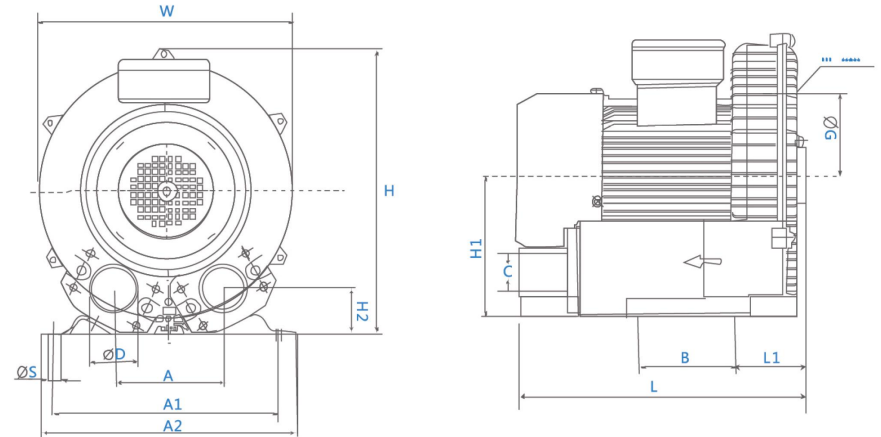
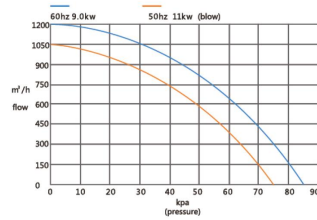
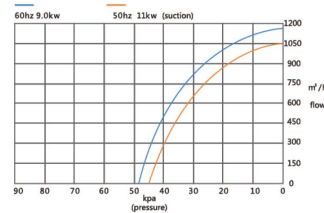

MODEL SIZE	L	W	H	H1	H2	A	A1	A2	L1	B	G	D	S	C
GB-90	205	184	200	96	32	80	158	172	55	56	—	Φ20	Φ7	—
GB-120	205	184	200	96	32	80	157	172	55	56	—	Φ20	Φ7	—
GB-180	223	200	212	110	36	86	184	204	62	66	—	Φ20	Φ7	—
GB-200	223	200	212	110	36	86	184	204	62	66	—	Φ20	Φ7	—
GB-250	260	246	247	120	37	90	205	235	62	83	Φ140	Φ49	Φ8.5	M41
GB-370	260	246	247	130	38	90	205	235	62	83	Φ140	Φ49	Φ10	M41
GB-550	277	268	272	155	47	93	205	265	66	83	Φ162	Φ49	Φ12	M41
GB-750	300	286	302	165	58	111	225	265	80	95	Φ173	Φ50	Φ12	M47
GB-1100	325	335	340	190	61.5	115	270	300	30	140	Φ200	Φ60	Φ14	M60
GB-1500	325	335	340	190	61.5	115	270	300	30	140	Φ200	Φ60	Φ14	M60
GB-2200	377	382	385	192	56	125	290	326	103	140	Φ256	Φ60	Φ14	M60
GB-3000	402	408	410	210	56	140	313	345	103	140	Φ256	Φ60	Φ14	M60
GB-4000	435	418	470	237	110	143	315	330	113	185	Φ280	Φ76	Φ14	G2½
GB-5500	475	446	480	250	118	148	360	465	100	170	Φ288	Φ76	Φ15	G2½
GB-7500	475	446	480	250	118	148	360	465	100	170	Φ288	Φ76	Φ15	G2½
GB-11000	660	550	570	300	92	207	360	415	89	—	490	110	—	G4

Type	Voltage V	Current A	Frequency Hz	Max Pressure KPa	Max flow m³/h	Max Vacuum KPa	Power kw	Rotational Speed r/min	Noise dB(A)	N.W. kg	G.W. kg	Packing Size (cm)
GB-7500S	△220 Y380	25.98(34.19) 15(19.74)	50(60)	45(52)	550(640)	35(42)	7.5(9.0)	2800(3400)	<70	65	74	48×50×52
GB-11000S	Y380	28(38)	50(60)	75(85)	1050(1200)	40(52)	11(12.5)	2800(3400)	<70	120	135	69×58×61

Exploded view

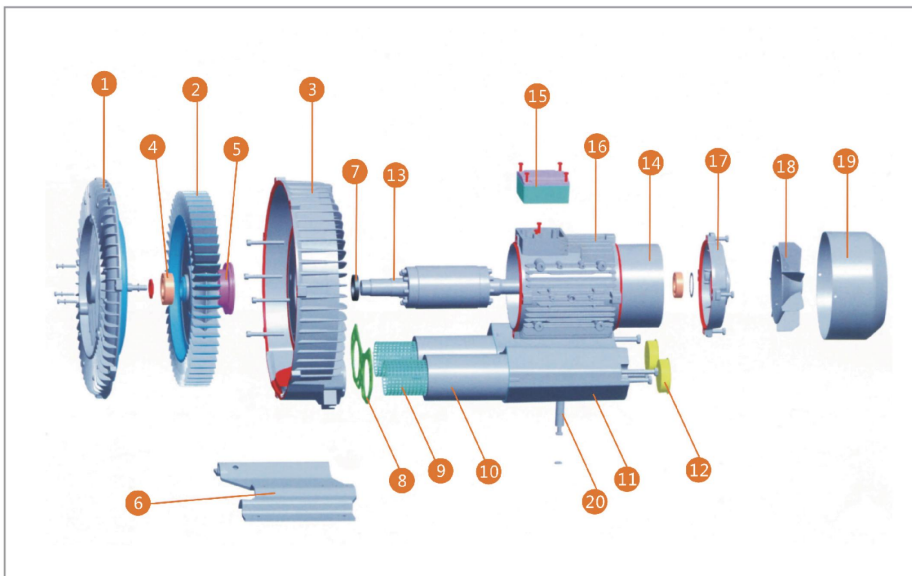

1、 Pump cover	2、 Impeller	3、 Pump body	4、 Bearing	5、 Bearing cover
6、 Seat	7、 Oil seal	8、 Gasket Shim	9、 Silencer net	
10、 Silencer sponge		11、 Silencer tube	12、 Joint(flange)	13、 Rotor
14、 Motor	15、 Terminal box	16、 Motor case		
17、 Motor end cover		18、 Fan	19、 Fan cover	20、 Supporting tube

GB-550/2



GB series vortex air pump performance curve
(for reference only, do not take it for testing standard)

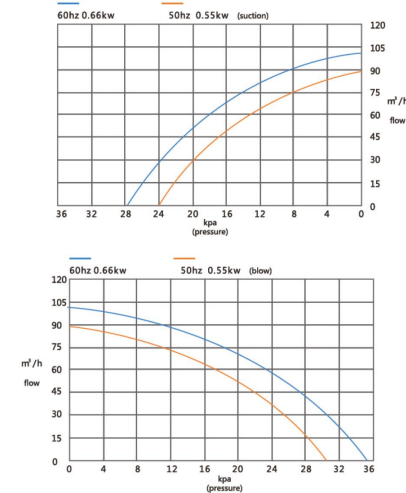

GB-750/2



GB series vortex air pump performance curve
(for reference only, do not take it for testing standard)

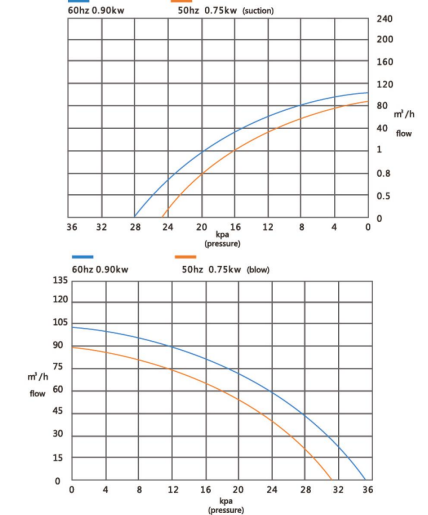

Type	Voltage V	Current A	Frequency Hz	Max Pressure KPa	Max flow m ³ /h	Max Vacuum KPa	Power kw	Rotational Speed r/min	Noise dB(A)	N.W. kg	G.W. kg	Packing Size (cm)
GB-550/2	220	4.8(5.76)	50(60)	30(35)	88(100)	24(27)	0.55(0.66)	2800(3400)	<60	17.5	18.5	32×30×31
GB-550S/2	Δ220 Y380	2.51(3.01) 1.45(1.74)	50(60)	30(35)	88(100)	24(27)	0.55(0.66)	2800(3400)	<60	17.0	18.0	32×30×31
GB-750/2	220	6.3(7.56)	50(60)	31(35)	88(100)	25(28)	0.75(0.90)	2800(3400)	<60	19.0	20.0	45×36×34
GB-750S/2	Δ220 Y380	3.31(4.10) 1.81(2.37)	50(60)	31(35)	88(100)	25(28)	0.75(0.90)	2800(3400)	<60	18.0	21.5	45×36×34

GB-1100S/2



GB-1500S/2



GB-2200S/2



GB-3000S/2

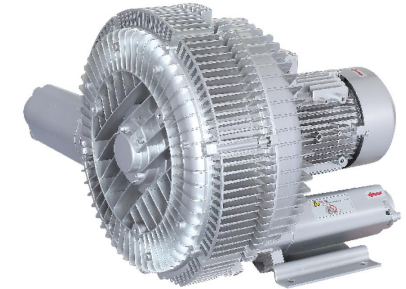

GB series vortex air pump performance curve
(for reference only, do not take it for testing standard)

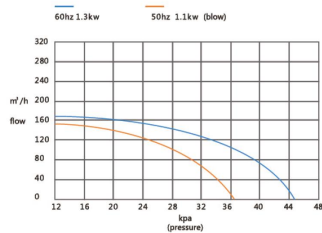
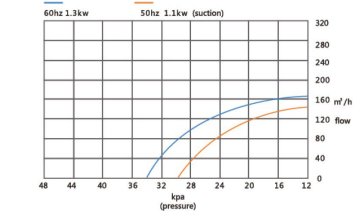

GB series vortex air pump performance curve
(for reference only, do not take it for testing standard)

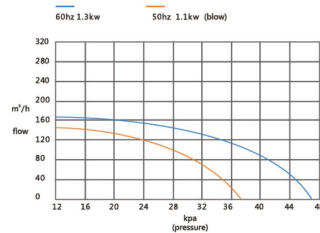
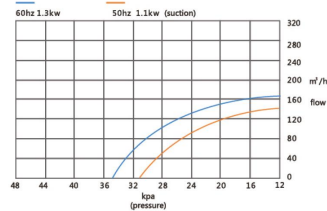

GB series vortex air pump performance curve
(for reference only, do not take it for testing standard)

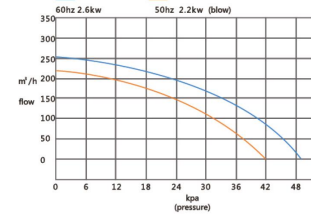
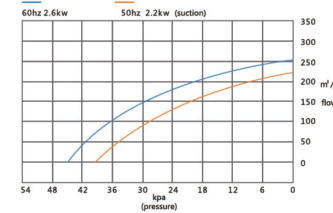

GB series vortex air pump performance curve
(for reference only, do not take it for testing standard)

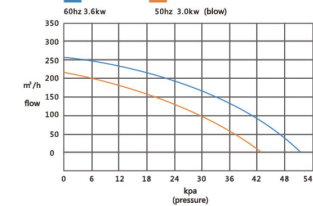
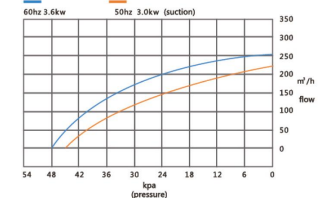

Type	Voltage V	Current A	Frequency Hz	Max Pressure KPa	Max flow m³/h	Max Vacuum KPa	Power kw	Rotational Speed r/min	Noise dB(A)	N.W. kg	G.W. kg	Packing Size (cm)
GB-1100/2	220	8.7(10.44)	50(60)	37(45)	145(170)	30(34)	1.1(1.3)	2800(3400)	<60	26	27	48×40×38
GB-1100S/2	Δ220 Y380	4.36(5.88) 2.52(3.42)	50(60)	37(45)	145(170)	30(34)	1.1(1.3)	2800(3400)	<60	24.5	25.5	48×40×38
GB-1500/2	220	11.8(14.16)	50(60)	38(47)	145(170)	31(35)	1.5(1.8)	2800(3400)	<60	27.2	28.2	48×40×38
GB-1500S/2	Δ220 Y380	5.96(8.20) 3.44(4.74)	50(60)	38(47)	145(170)	31(35)	1.5(1.8)	2800(3400)	<60	26	27	48×40×38

Type	Voltage V	Current A	Frequency Hz	Max Pressure KPa	Max flow m³/h	Max Vacuum KPa	Power kw	Rotational Speed r/min	Noise dB(A)	N.W. kg	G.W. kg	Packing Size (cm)
GB-2200S/2	Δ220 Y380	8.52(10.22) 4.92(5.91)	50(60)	42(49)	220(255)	39(44)	2.2(2.6)	2800(3400)	<70	37.8	43.3	50×43×42
GB-3000S/2	Δ220 Y380	11.07(13.29) 6.39(7.67)	50(60)	43(50)	220(255)	44(48)	3.0(3.6)	2800(3400)	<70	39	46.5	55×45×45

GB-4000S/2

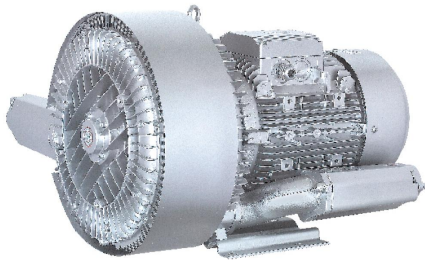

GB series vortex air pump performance curve (for reference only, do not take it for testing standard)

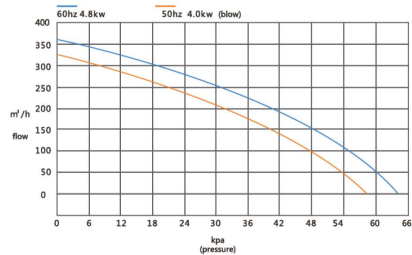
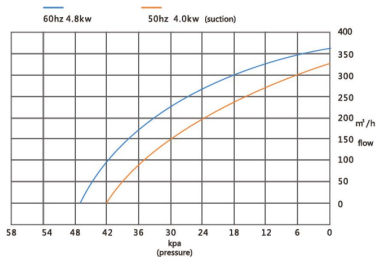

GB-5500S/2

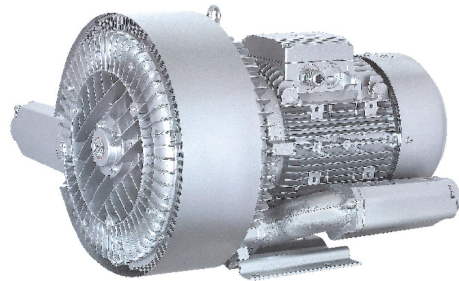

GB series vortex air pump performance curve (for reference only, do not take it for testing standard)

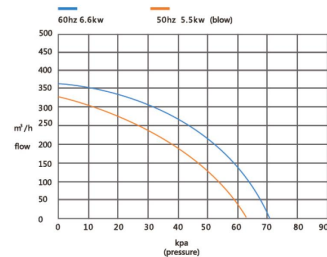
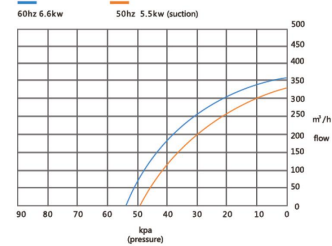

Type	Voltage V	Current A	Frequency Hz	Max Pressure KPa	Max flow m³/h	Max Vacuum KPa	Power kw	Rotational Speed r/min	Noise dB(A)	N.W. kg	G.W. kg	Packing Size (cm)
GB-4000S/2	Δ220 Y380	14.15(16.97) 8.17(9.8)	50(60)	57(64)	325(360)	42(47)	4.0(4.8)	2800(3400)	<70	55	65	55×51×42
GB-5500S/2	Δ220 Y380	19.23(23.21) 11.1(13.4)	50(60)	63(71)	325(360)	48(54)	5.5(6.6)	2800(3400)	<70	85	98	67×50×50





Blow, Dust collection, Exhaust, Cooling, Transport, Air lifting

Application of Blow:

The gas and heavy oil gush out firing <p>high wind pressure(2.00mmAq) and enough wind amount,can lightening your reliance to the air compress horizontal.</p>	Wash the bottle machine and dries up <p>empty bottle of beverage are water-washed,suitable for the food industry.</p>	Can collect all the bits automaticall after cut the Paper <p>plastic, cloth, paper, etc. out.</p>	It is dry to use the air knife <p>electron industry can make use of forced draught blower to blowdown the small dust and water droplet.</p>
Air cushion <p>increasing the buoyancy, easy to move.</p>	The domestic animal excrement ferments' fierceness gas <p>entering domestic animal' s excrement trough filtrationously with high-pressure air, it is exposed to the area to increase domestic animal excrement and air.Also suitable for the sewage disposal of the public hazards.</p>	Subpoena transport <p>it regards air as motive force to be fast also teally to transport file.</p>	The electrolytic liquid mix round <p>makes use of air to stir the electrolytic trough,make the electrolytecirculate, and repel adhering to the bubble and make electroplate rapidly the result is even.(export hoses with the best of 4mm)</p>
The oxygen supply in breed aquatice <p>water in the pool</p>	Puncher machine <p>convenient to is it press product of taking shape after to take out.</p>	Powder body transport <p>powder body grains of body,etc. air of raw materials transport.</p>	Combustion-supporting discharge with the waste gas of the incinerator <p>atmdpspherical help blaze and exhaust</p>
The exhaust gas blows smoking <p>discharging rapidly by the scattered exhaust gas that appears,so as not to cause pollution.</p>	Wash the car and dry up <p>blow the moisture content to dry after having car machine washing.</p>	Print and force dryness <p>enabling the printing color to dry fast.</p>	Dry up after cleaning <p>moisture content or oil gas after cleaning break away from articles rapidly</p>

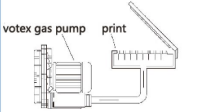
Blow,Dust collection,Exhaust,Cooling,Transport,Air lifting

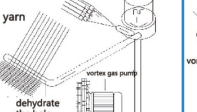
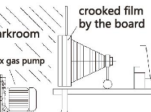
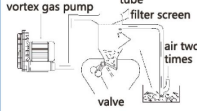
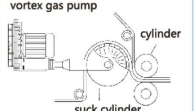
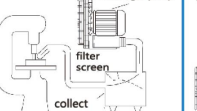
Application of Suction:

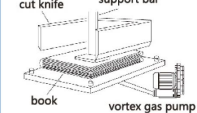
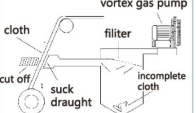
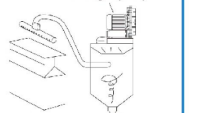
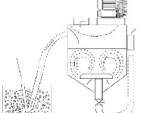
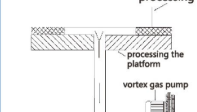
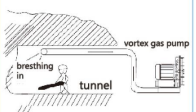
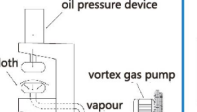
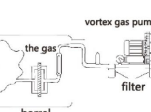
<p>The sucking of the printing machine of network edition</p>  <p>printed matter utilize the pressure of sucking to be regular, in order to make it easy for print</p>	<p>Eject the exhaust gas and dust produced while welding drawing</p>  <p>vacuum way is arranged to the elsewhere,ensure operators to be healthy.</p>	<p>The weave cotton machine suck silk</p>  <p>absorb the moisture content and regular end of a thread,improve the quality and efficiency of the products.</p>	<p>Photo-engraving</p>  <p>make use of vacuum suction to keep films,make it smooth,is suitable for photo-engraving industry.</p>
<p>The powder body transports</p>  <p>granular object,for instance plastic raw materials,etc.can make use of the atmospheric pressure(blow)or the vacuum suction to accomplish the task of sending.</p>	<p>Print suck</p>  <p>vacuum suck printing paper is it transfer by molding</p>	<p>Industry hoover</p>  <p>in the factory for bits platform of remaining etc,it is the all right it have Fig.it have the clean the ways</p>	<p>Vacuum dehydrate</p>  <p>the paper pulp dehydrates,pollution dehydrates,the cloth dehydrates ect.</p>
<p>Make books machine</p>  <p>cut off when keep sucking.</p>	<p>Incomplete cloth deal with</p>  <p>cloth cutting treatment.</p>	<p>Ox milk paper carton filling machine</p>  <p>ox milk vacuum that box is fill attract and utilize.</p>	<p>Bean curd machinery</p>  <p>tracting the soybean whele to give, clean and use to cleaning the trough.</p>
<p>keeping processing</p>  <p>block of processing thing, plastic,etc. using regularly for some un-magnetism object's fixing.</p>	<p>Defence works scene</p>  <p>for remove the part of the tunnel and narrow and small part's dust and poisonous gas.</p>	<p>Lron cloth machine</p>  <p>spend to discharge the vapour when ironing cloth.</p>	<p>The gas resolves</p>  <p>using the attraction of the gas resolves device.</p>

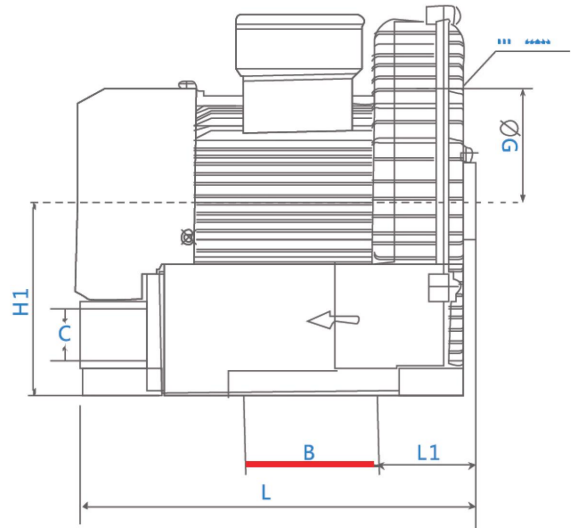
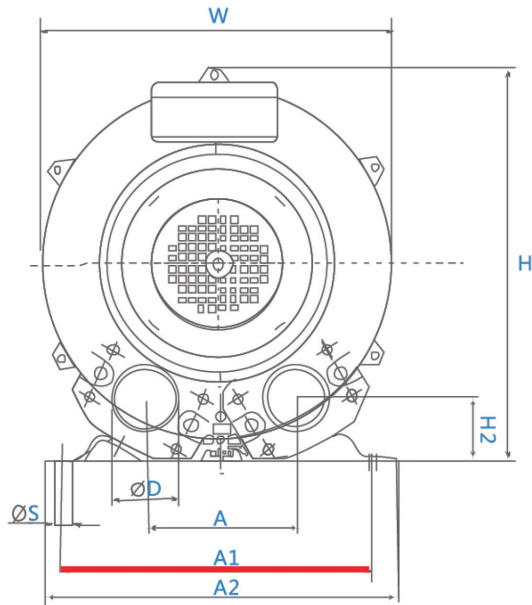

MODEL SIZE	L	W	H	H1	H2	A	A1	A2	L1	B	G	D	S	C
GB-90	205	184	200	96	32	80	158	172	55	56	—	Φ20	Φ7	—
GB-120	205	184	200	96	32	80	157	172	55	56	—	Φ20	Φ7	—
GB-180	223	200	212	110	36	86	184	204	62	66	—	Φ20	Φ7	—
GB-200	223	200	212	110	36	86	184	204	62	66	—	Φ20	Φ7	—
GB-250	260	246	247	120	37	90	205	235	62	83	Φ140	Φ49	Φ8.5	M41
GB-370	260	246	247	130	38	90	205	235	62	83	Φ140	Φ49	Φ10	M41
GB-550	277	268	272	155	47	93	205	265	66	83	Φ162	Φ49	Φ12	M41
GB-750	300	286	302	165	58	111	225	265	80	95	Φ173	Φ50	Φ12	M47
GB-1100	325	335	340	190	61.5	115	270	300	30	140	Φ200	Φ60	Φ14	M60
GB-1500	325	335	340	190	61.5	115	270	300	30	140	Φ200	Φ60	Φ14	M60
GB-2200	377	382	385	192	56	125	290	326	103	140	Φ256	Φ60	Φ14	M60
GB-3000	402	408	410	210	56	140	313	345	103	140	Φ256	Φ60	Φ14	M60
GB-4000	435	418	470	237	110	143	315	330	113	185	Φ280	Φ76	Φ14	G2½
GB-5500	475	446	480	250	118	148	360	465	100	170	Φ288	Φ76	Φ15	G2½
GB-7500	475	446	480	250	118	148	360	465	100	170	Φ288	Φ76	Φ15	G2½
GB-11000	660	550	570	300	92	207	360	415	89	—	490	110	—	G4

Air Filter:



MF-08



MF-10



MF-12



MF-16



MF-20



MF-32

Dimension:

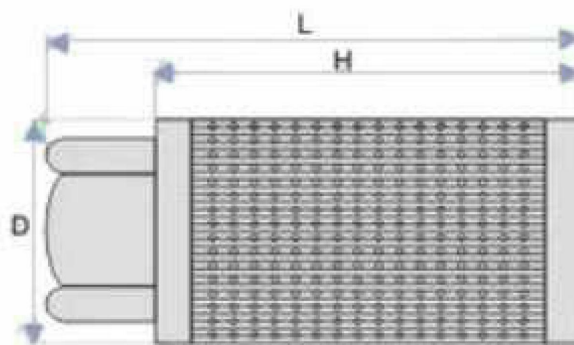
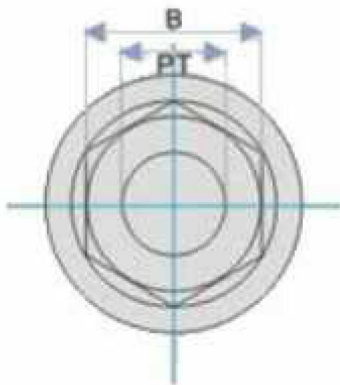

Dimension:

Model:	PT	D (mm)	L (mm)	H (mm)	B (mm)	Fineness (mesh)	Flow (L/min)	Weight(kg)
MF-08	1	58	170	155	42	100	110	0.2
MF-10	1 1/4	71	186	170	54	100	210	0.35
MF-12	1 1/2	85	196	182	65	100	285	0.49
MF-16	2	103	215	202	75	100	395	0.65
MF-20	2 1/2	148	274	252	97	100	750	1.2
MF-32	4	208	380	357	142	100	1000	2.45

Relief Valve

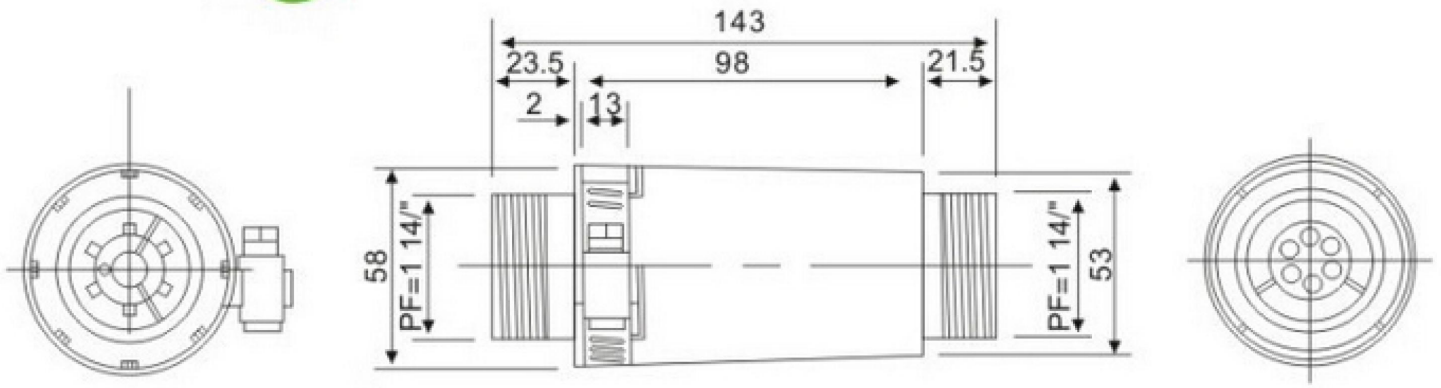

型号 Model	口径 Caliber	L (mm)	规格 Specification
PV-01	1 1/4"	143	0~3000mmAq
PV-02	1 1/4"	143	0~6000mmAq

